

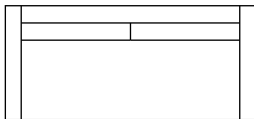

N.C. MADE

# THE SUNDAY DOWN-SLOPE ARM

WITH LARGE FRONT RAIL • 2" LEGS



<b>53020</b>
108lbs.   LOVESEAT
TOTAL   W59" D37" H32"
SEAT   W53" D22" H18"
ARMS   --- --- H24"

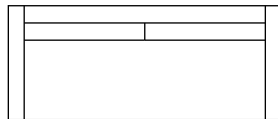

<b>53035</b>
115lbs.   APARTMENT SOFA
TOTAL   W76" D37" H32"
SEAT   W68" D22" H18"
ARMS   --- --- H24"

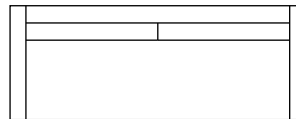

<b>53030</b>
140lbs.   86" SOFA
TOTAL   W86" D37" H32"
SEAT   W78" D22" H18"
ARMS   --- --- H24"

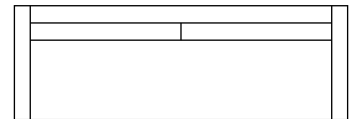

<b>53080</b>
170lbs.   96" SOFA
TOTAL   W96" D37" H32"
SEAT   W88" D22" H18"
ARMS   --- --- H24"

SUNDAY DOWN-SLOPE ARM ALSO AVAILABLE WITH THIN FRONT RAIL AND 7" LEGS AS 580 GROUP. SEE 1:1 BOOKLET FOR MORE INFORMATION. SEE REVERSE FOR SECTIONAL OPTIONS.



<b>50009</b>	<b>CORNER CHAIR</b>
80lbs.	
<b>TOTAL</b>	W37" D37" H32"
<b>SEAT</b>	W22" D22" H18"
<b>ARMS</b>	--- --- ---



<b>53011</b>	<b>RIGHT ARM CHAIR</b>
80lbs.	
<b>TOTAL</b>	W30" D37" H32"
<b>SEAT</b>	W26" D22" H18"
<b>ARMS</b>	--- --- H24"



<b>53012</b>	<b>LEFT ARM CHAIR</b>
80lbs.	
<b>TOTAL</b>	W30" D37" H32"
<b>SEAT</b>	W26" D22" H18"
<b>ARMS</b>	--- --- H24"



<b>50013</b>	<b>ARMLESS CHAIR</b>
80lbs.	
<b>TOTAL</b>	W26" D37" H32"
<b>SEAT</b>	W26" D22" H18"
<b>ARMS</b>	--- --- ---

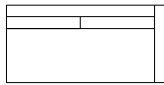

<b>53021</b>	<b>R. ARM LOVESEAT</b>
108lbs.	
<b>TOTAL</b>	W56" D37" H32"
<b>SEAT</b>	W53" D22" H18"
<b>ARMS</b>	--- --- H24"

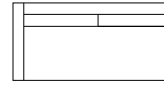

<b>53022</b>	<b>L. ARM LOVESEAT</b>
108lbs.	
<b>TOTAL</b>	W56" D37" H32"
<b>SEAT</b>	W53" D22" H18"
<b>ARMS</b>	--- --- H24"

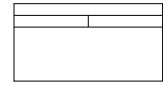

<b>50023</b>	<b>ARMLESS LOVESEAT</b>
95lbs.	
<b>TOTAL</b>	W52" D37" H32"
<b>SEAT</b>	W52" D22" H18"
<b>ARMS</b>	--- --- ---

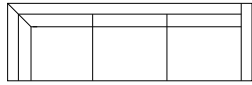

<b>53031</b>	<b>R. CORNER SOFA</b>
180lbs.	
<b>TOTAL</b>	W92" D37" H32"
<b>SEAT</b>	W79" D22" H18"
<b>ARMS</b>	--- --- H24"

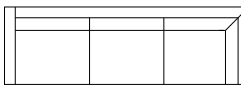

<b>53032</b>	<b>L. CORNER SOFA</b>
180lbs.	
<b>TOTAL</b>	W92" D37" H32"
<b>SEAT</b>	W79" D22" H18"
<b>ARMS</b>	--- --- H24"

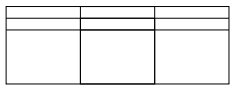

<b>50033</b>	<b>ARMLESS SOFA</b>
120lbs.	
<b>TOTAL</b>	W78" D37" H32"
<b>SEAT</b>	W78" D22" H18"
<b>ARMS</b>	--- --- ---

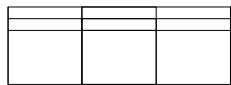

<b>53033</b>	<b>R. ARM SOFA</b>
125lbs.	
<b>TOTAL</b>	W82" D37" H32"
<b>SEAT</b>	W78" D22" H18"
<b>ARMS</b>	--- --- H24"

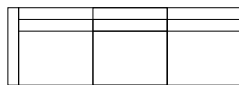

<b>53034</b>	<b>L. ARM SOFA</b>
125lbs.	
<b>TOTAL</b>	W82" D37" H32"
<b>SEAT</b>	W78" D22" H18"
<b>ARMS</b>	--- --- H24"

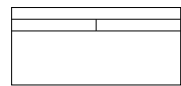

<b>50035</b>	<b>ARMLESS APT. SOFA</b>
100lbs.	
<b>TOTAL</b>	W68" D37" H32"
<b>SEAT</b>	W68" D22" H18"
<b>ARMS</b>	--- --- ---

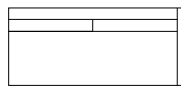

<b>53036</b>	<b>R. ARM APT. SOFA</b>
125lbs.	
<b>TOTAL</b>	W72" D37" H32"
<b>SEAT</b>	W68" D22" H18"
<b>ARMS</b>	--- --- H24"

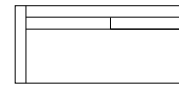

<b>53037</b>	<b>L. ARM APT. SOFA</b>
125lbs.	
<b>TOTAL</b>	W72" D37" H32"
<b>SEAT</b>	W68" D22" H18"
<b>ARMS</b>	--- --- H24"

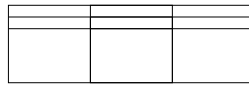

<b>50039</b>	<b>LG. ARMLESS SOFA</b>
140lbs.	
<b>TOTAL</b>	W88" D37" H32"
<b>SEAT</b>	W88" D22" H18"
<b>ARMS</b>	--- --- ---

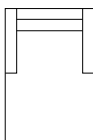

<b>53060</b>	<b>CHAISE</b>
125lbs.	
<b>TOTAL</b>	W38" D63" H32"
<b>SEAT</b>	W30" D22" H18"
<b>ARMS</b>	--- --- H24"

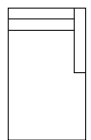

<b>53061</b>	<b>R. ARM CHAISE</b>
125lbs.	
<b>TOTAL</b>	W34" D63" H32"
<b>SEAT</b>	W30" D22" H18"
<b>ARMS</b>	--- --- H24"

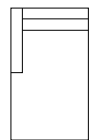

<b>53062</b>	<b>L. ARM CHAISE</b>
125lbs.	
<b>TOTAL</b>	W34" D63" H32"
<b>SEAT</b>	W30" D22" H18"
<b>ARMS</b>	--- --- H24"



<b>50063</b>	<b>ARMLESS CHAISE</b>
125lbs.	
<b>TOTAL</b>	W30" D63" H32"
<b>SEAT</b>	W30" D22" H18"
<b>ARMS</b>	--- --- ---

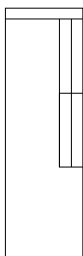

<b>50071</b>	<b>R. ARM BUMPER</b>
136lbs.	
<b>TOTAL</b>	W37" D85" H32"
<b>SEAT</b>	W22" D70" H18"
<b>ARMS</b>	--- --- ---

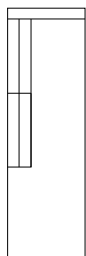

<b>50072</b>	<b>L. ARM BUMPER</b>
136lbs.	
<b>TOTAL</b>	W37" D85" H32"
<b>SEAT</b>	W22" D70" H18"
<b>ARMS</b>	--- --- ---

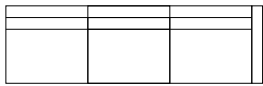

<b>53081</b>	<b>R. ARM LG. SOFA</b>
160lbs.	
<b>TOTAL</b>	W92" D37" H32"
<b>SEAT</b>	W88" D22" H18"
<b>ARMS</b>	--- --- H24"

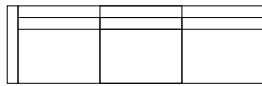

<b>53082</b>	<b>L. ARM LG. SOFA</b>
160lbs.	
<b>TOTAL</b>	W92" D37" H32"
<b>SEAT</b>	W88" D22" H18"
<b>ARMS</b>	--- --- H24"

SUNDAY DOWN-SLOPE ARM ALSO AVAILABLE WITH THIN FRONT RAIL AND 7" LEGS AS 580 GROUP.  
SEE 1:1 BOOKLET FOR MORE INFORMATION.