

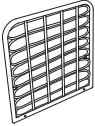

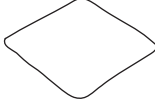





**ITEM NAME/NOM D'ITEM: KAPALUA MIDDLE CHAIR**

**ITEM # /NO. ITEM: 703958**

**PARTS LIST/LISTE DES PIÈCES**

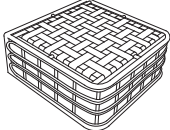
(1)	(3)	(5)
 x1	 x1	A.  M6x20mm x2 B.  M6x35mm x2
(2)	(4)	C.  $\Phi 10 \times 1.0 \text{mm}$ x4 D.  4mm x1 E.  connector x2
 x1	 x1	

**ASSEMBLY INSTRUCTIONS/INSTRUCTIONS D'ASSEMBLAGE**

**I**

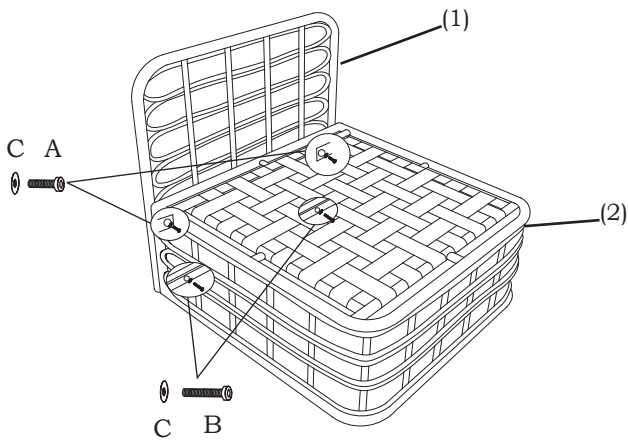

**II**

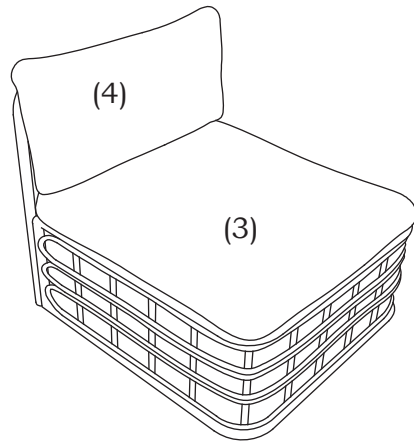

**Connection Illustration**

